

Honeywell Homes T3, T3M & T3R

PRODUCT SPECIFICATION SHEET



Honeywell T3 & T3M
Programmable Thermostat



Honeywell T3R
Programmable Thermostat

The **T3, T3M & T3R** thermostats are designed to provide automatic time and temperature control of heating systems in homes and apartments. The T3 is compatible with 24-230V on/off appliances such as gas boilers, combi-boilers and heat pump. Also works with zone valve applications but not with electric heating (240V). The T3M and T3R versions support also OpenTherm® appliances.

The T4 and T4M are for wired on the wall installations and the T4R for wireless installations. T3R exist of a thermostat and a Receiver box.

The solution is designed with the installer in mind and includes a receiver module with mounting options for directly on the wall or on a wall box. Wiring can be from below or from the back by lifting the terminal platform, which makes installation quick and easy.

The **thermostat** has a large and clear fix segment display with backlight, simple programming philosophy all to make it easier to install and very user friendly.

The T3 product line is ideal for consumers who want to control their comfort remotely with a modern design, simple to program and easy to use product.

FEATURES

- Minimalistic and modern design makes it easy to blend in any type of homes.
- Table stand or wall mounted thermostat options to fit new and replacement installations.
- Backlight for easier viewing in all light conditions.
- Factory programmed daily, or 5+2 default heating schedule.
- Schedule options with 4 independent set-points to suit comfort needs.
- Set-point temperature always displayed.
- OFF position has an integral frost protection setting at minimum 5 °C so that pipes in the house will never freeze.
- Alert messages to assist in fault finding.
- Timed override function allows to hold a targeted set point for 1 hour.
- Automatic time clock adjustment for “Daylight Saving Time”.
- Receiver box with clear LED indication and override button.
- On/Off or OpenTherm® (T3M) compatible control.
- User menu allows extra functions to be set at the discretion of the user:
 - Heating schedule
 - Date and time setting
 - Optimisation
 - Lock function
 - OpenTherm® alerts (T3M only)
- Installer menu allows extra functions to be set at the discretion of the installer to match the homeowner’s applications and needs:
 - Language selection
 - Cycle rate
 - Upper / Lower set point limit adjustment
 - Minimum ON/OFF time
 - Daily, weekly or 5+2 schedule option
 - 4 periods a day
 - Wired remote sensor
 - Fail safe mode
 - Clock format
 - Daylight saving time change (DST)
 - Temperature display offset
 - Factory reset
 - Binding (T3R only)

T3 PROGRAMMABLE THERMOSTAT

THERMOSTAT DISPLAY/BUTTON LAYOUT

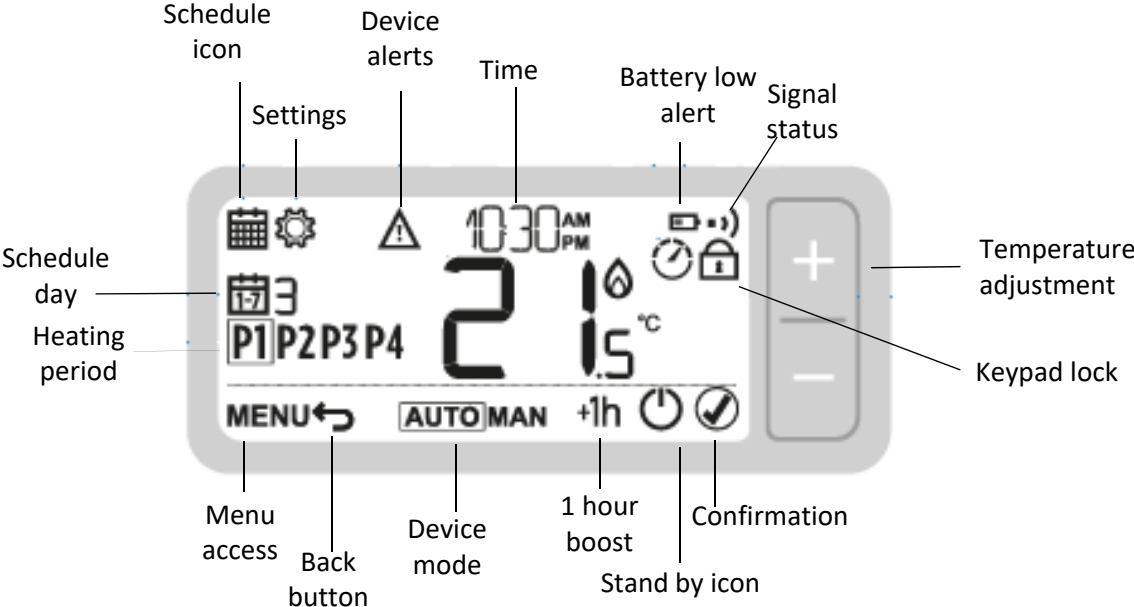

RECEIVER BOX INTERFACE

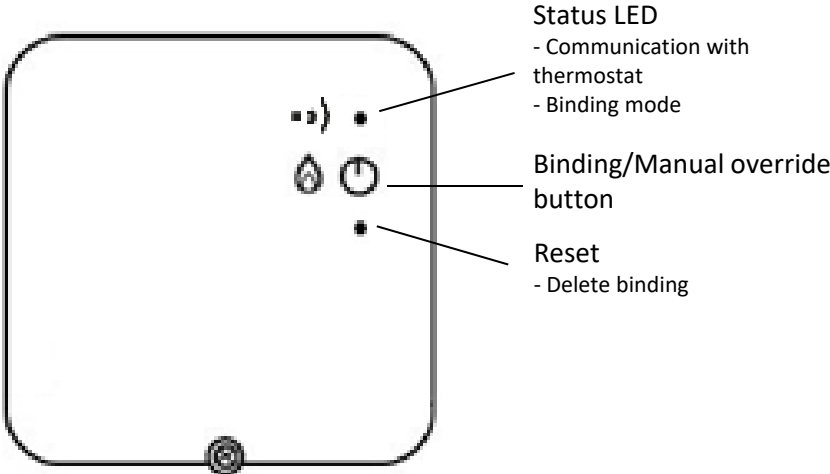

T3 PROGRAMMABLE THERMOSTAT

SPECIFICATIONS

T3/T3M/T3R Thermostat

Control form	: Fuzzy Logic
Room temperature display range	: From 0 °C to 50 °C
Dimensions (w x h x d)	: T3/T3M: 136 x 97 x 26 mm T3R (Wireless) 136 x 98 x 62 mm
Time display	: 24 hour or 12 hour AM/PM format
Time keeping accuracy	: +/- 10mins per year
Program	: 5+2 or daily schedule with 4 daily time and temperature level changes
Time setting resolution	: Program – 10 minute steps
Sensing element	: 10k(@25 °C) NTC thermistor
Temperature Setting range	: Program: 5 to 35 °C OFF : 5 °C
Power	: Powered by 2 x AA batteries
Wiring	: T3(wired) and T3M (OpenTherm) terminal block capable of accepting wired up to 1.5 mm ²

RF communication

RF operation band	: ISM (868.0-868.6) MHz, 1% duty cycle
Max, power	: 25mW
Protocol	: Encrypted
Comm. Range	: 30m in residential building environment
Comm. Technology	: short, high rate transmissions to minimise air time and avoid collisions
Receiver class R.E.D.	: RX Cat 2 (ETSI EN300 220-1 version 1.3.1)

Receiver box



Power	: 230VAC
Electrical rating	: 230V~, 50..60Hz, 0.5A to 5A resistance 0.5A to 3A inductive (0.6 pf) 24V~, 50..60Hz, 0.5A to 5A resistance 0.5A to 3A inductive (0.6 pf)
Cycle rate	: Selectable by application (see installer set up)
Wiring	: Terminal block capable of accepting wires up to 1.5 mm ²
Wire access	: From back via large wall box opening. From bottom with cable clamps. Mains wiring – left Low voltage wiring - right
Dimensions (w x h x d)	: 110 x 110 x 40 mm
IP class	: 30

Environmental and standards

Operating temperature range	: 0 to 40 °C
Shipping and storage temperature	: -20 to 55 °C
Humidity range	: 10 to 90% rh, non- condensing
EMC	: 2014/30/EU
LVD	: 2014/35/EU
R&TTE	: 1995/5/EC
Wire access	: From back via large wall box opening.
ErP	: Class IV (+2%), (EU) 811/2013 (T4) Class V (+3%), (EU) 811/2013 (T4R) Class VI (+4%), (EU) 811/2013 (T4M)
Honeywell, declares that this thermostat is in compliance with the essential requirements and other relevant provisions of Directive 2014/53/EU	

T3 PROGRAMMABLE THERMOSTAT

INSTALLER MENU

To enter the Installer menu press the  button and then  until the display changes (approx. after 3 secs)

Specific Applications		Setting		What do you need to change?
		CpH (cycle per hour)	Minimum on Time (min)	Note: a. To change cycle per hour b. To change minimum ON time
Heating	Gas Boilers (30kW)	6	1	No action required
	Oil Boiler	3	4	a. Set minimum ON time to 4 minutes. b. Set cycle per hour to 3.
	Thermal Actuator	12	1	Set cycle per hour to 12.
	Zone valve	6	1	No actions required
Special Features		Description		
Opentherm®		By connecting the T3M to an OpenTherm® appliance various specific data can be viewed. The data is depending on what the appliance is providing.		
Heat range		The normal lower temperature limit of 5 °C can be increased up to 21 °C to protect the inhabitants from cold. Useful if the inhabitants include the elderly, children or disabled. The normal upper temperature limit of 37 °C can be reduced down to 21 °C to save the homeowner energy. Useful if the homeowner rents to tenants.		
Schedule options		The thermostat has the 7 days by default, however it can be change to 7 days for different schedule each day of the week or 1 day for having the same schedule during the week		
External temperature sensor (only for wired versions)		An external temperature sensor can be fitted, allowing the thermostat to control the temperature from another room or space, where it is inconvenient to locate the thermostat. It will read the remote sensor every 1 minute. The sensor can be connected up to 50 meters from the unit. Useful for commercial premises where the public may tamper with the product		
Optimisation (optimum start, optimum stop and delayed start)		<p>Optimum Start: learns how long it takes your system to reach the temperature you want. It turns on the heating system earlier to make sure it's comfortable at the scheduled time.</p> <p>Optimum Stop: Saves energy and money by switching off a little bit earlier than the normal programmed time. If the home is up to temperature, it will not notice the effect on the temperature, but will show a difference in the fuel bill.</p> <p>Delayed start: Saves energy by slightly delaying the start of heating depending on the difference between the scheduled temperature and the actual room temperature.</p>		
Clock setting		Change display format (default 24hr) and adjust time and date.		
Temperature offset		If the Thermostat is located in a hot/cold location and cannot be moved because of wiring then the measured/ displayed temperature can be adjusted by +/- 3 °C. Useful if the homeowner wants the reading to match another appliance temperature display.		
Binding (only for T4R)		Menu to bind the Thermostat and the Receiver box, test the RF signal strength of the radio communication and to clear an existing binding.		
Reset		Reset the thermostat back to factory default settings, reset the schedule to default.		
Failsafe		When the temperature sensor fails(T3,T3M) or the radio communication between the Thermostat and the Receiver box is lost the device will cycle the demand 20% On / 80% Off		

T3 PROGRAMMABLE THERMOSTAT

Menu item	Default	What do you need to change?
1LA:Language	1=English	1=English
2CR:Cycle rate	6	3,6,9,12
3OT:Min on time	1	1,2,3,4 or 5 minutes
4LL:Lower Temperature	5	5 °C to 21°C
5UL:Upper Temperature	25	21°C to 35°C
6SO:Schedule options	5+2	1= 7 day (different schedule each day of the week) 2= 5+2 (weekday + weekend schedule)
9LC:Fail safe mode	0	0= Deactivated 1= Activated
10BL:Backlight	1	0= Deactivated 1= Activated (only on demand)
11CL:Clock format	0	0= 24h 1= 12h (AM/PM)
12DS:Daylight saving time change	1	0= Deactivate Daylight saving time change 1= Automatically change time during DST
13TO:Temperature offset	0	-3°C to + 3 °C
15SD: Restore schedule	0	0 1= Reset the default schedule
16FS: Restore factory settings	0	0 1= Reset the device to factory settings
17OP: Optimum Start	0	0= Disable 1= Enable Optimum Start 2= Enable Delayed Start
18OS: Optimum Stop	0	0= Disable 1= Enable Optimum Start
19LK	1	1 = Partial Lock 2 = Full Lock

T3 PROGRAMMABLE THERMOSTAT

INSTALLATION

To ensure your safety, **always make sure mains power is switched OFF** before accessing wiring.

Before removing the old thermostat take a picture of the old thermostat's wiring as a reference then proceed to installation.

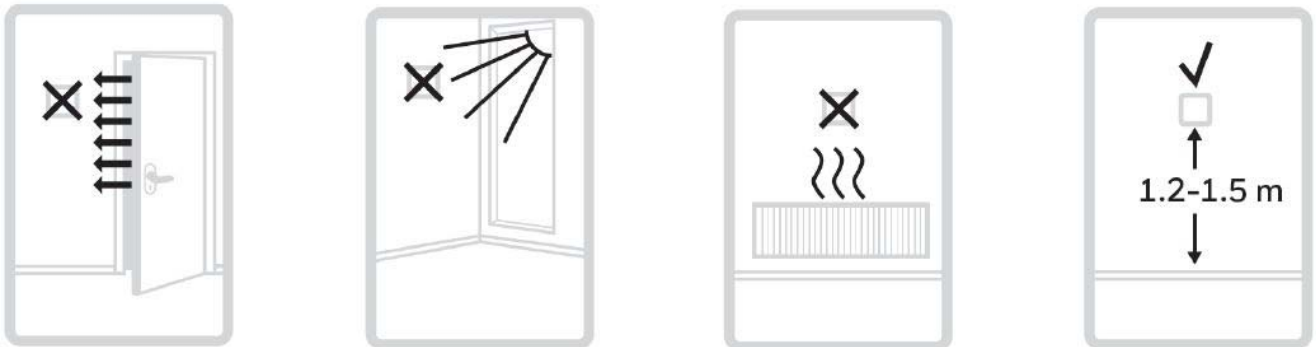

The T3 thermostat should not be placed near draughts, in direct sunlight or near heat sources. It should be at least 1.2 - 1.5 meters from the floor.

Prepare Receiver Box (T3R only)

Needed during installation:

- Cable with 2 wires from boiler to Receiver Box (R3H710RF0005).
- The Receiver Box requires 230V power.

Find a suitable location near the boiler. Leave **at least 30cm** distance from any metal objects including wall boxes and boiler housing.

Loosen the front screw to remove cover or tighten it when the cover is back in position.

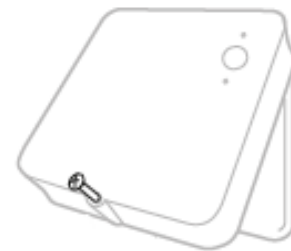

Install Receiver Box (T3R only)

A. Wall box or Rear wiring

B. Surface wiring

C. Replace cover

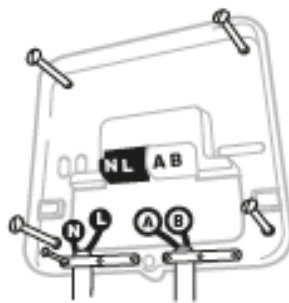

Complete installation(T3R)

Turn mains powers ON to the heating application and the receiver box

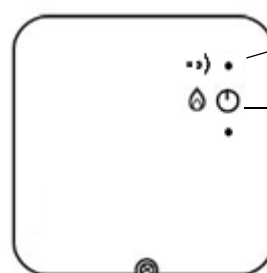

After powering up both devices the status LED should be steady GREEN

Press the manual override to check if the boiler switches ON. The button LED lights should light GREEN

T3 PROGRAMMABLE THERMOSTAT

Install Thermostat(T3 and T3M only)

A. Wall plate

Mount the back-plate to the wall.
Connect wires according to wiring diagrams.

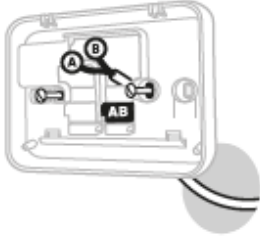

B. Surface wiring

Attach the front cover to the back plate.

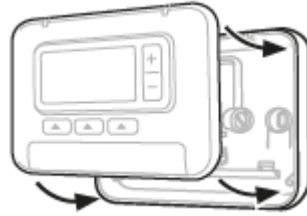

C. Place thermostat

Fit the flap on to the thermostat

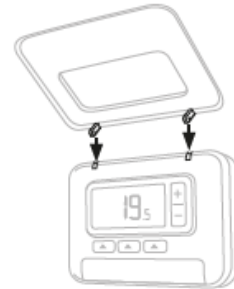

Power Up the Thermostat (T3 and T3R only)

Insert the batteries



Setup and Configuration

After power up, the year selection is displayed on the thermostat's screen.
Press + or – to adjust the date and time and press ✓ to confirm

BINDING(T3R only)

The T3R thermostat wireless kit comes pre-bound from the factory.

The binding operation described below is only required if:

- The T3 thermostat or the Receiver box is replaced
- The T3 thermostat or the Receiver box has incorrect or no binding data stored

To bind/rebind

Note: When the Receiver box has been bound before, first press with a small pin the pinhole for approximately 3 seconds to reset the binding, LEDs will flash amber for a moment.

1. Put the Receiver box into binding mode by pressing the button for 3 secs.
The LED will flash amber.
2. Enable binding on thermostat:
Enter binding menu by pressing and hold the ≡ for 3 secs and the press the – button.
Change parameter 14A to 1 and press ✓ to confirm
3. When binding is successful:
The ⋯) will appear on the thermostat's screen.
The Receiver box status LED will show steady green

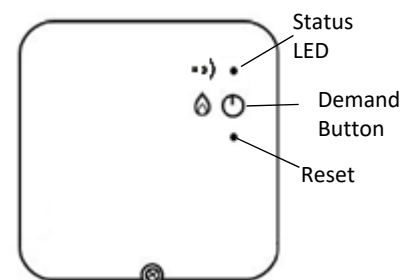

T3 PROGRAMMABLE THERMOSTAT

WIRING (T3 and T3M only)

ON/OFF boiler (230V)

Combi boiler

2 Port Zone Valve

Opentherm boiler

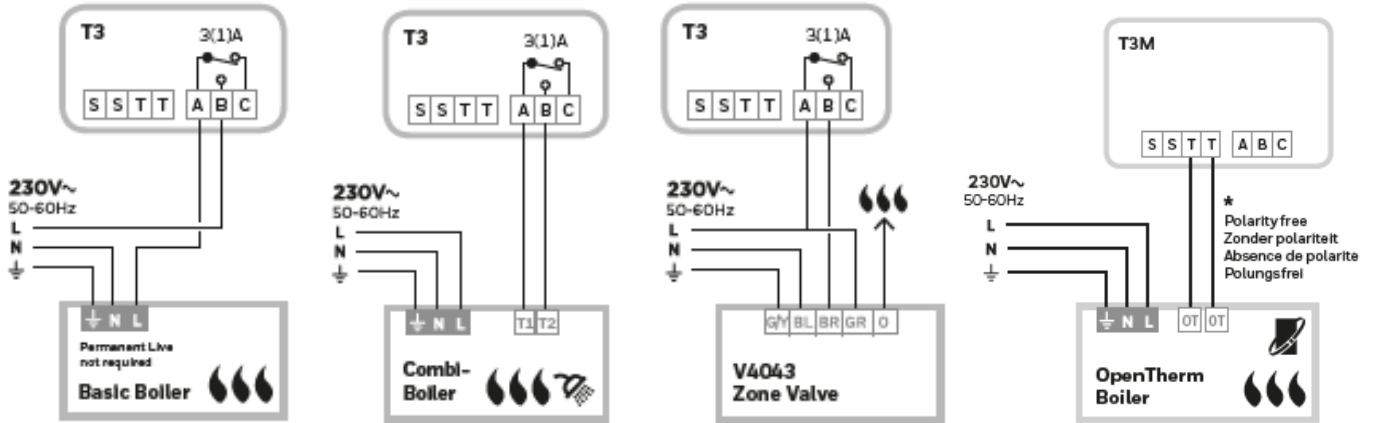

WIRING (T3R only)

ON/OFF boiler (230V)

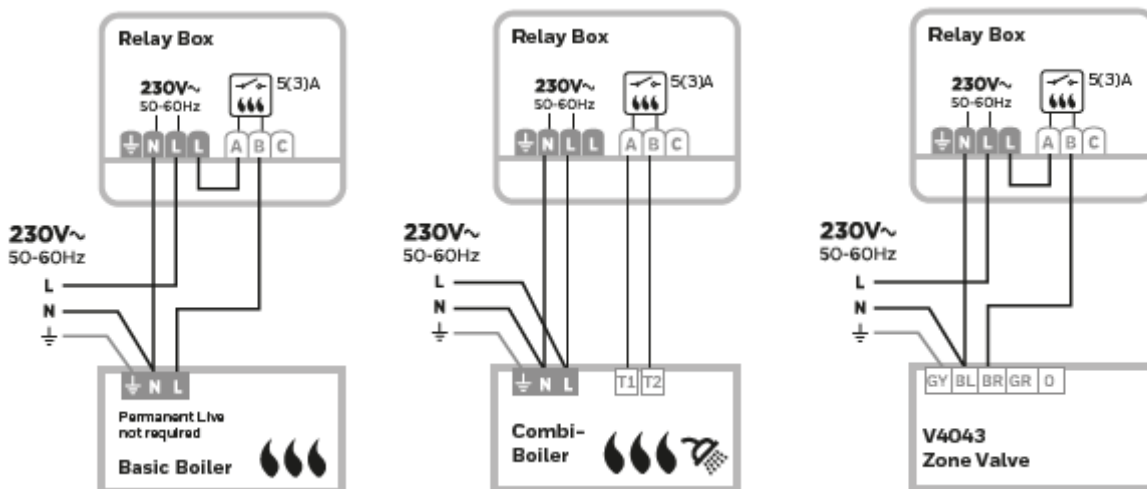

Combi boiler

2 Port Zone Valve











T3 PROGRAMMABLE THERMOSTAT

TROUBLESHOOTING – T3 and T3M only

Problem Display	Possible Cause	Remedy
Thermostat display is blank	Batteries exhausted, installed incorrectly or tab hasn't been removed	Unclip thermostat from wall and check battery installation - replace batteries if necessary
Display shows  (only for T3)	Battery power critically low	Unclip thermostat from wall and replace batteries immediately
Display shows 	Faulty temperature sensor	Replace thermostat or check wiring to remote temperature sensor if fitted
Thermostat shows heat demand  but boiler doesn't respond	a. Boiler water already at temperature b. Faulty wiring connection	a. Normal behaviour – wait for water temperature to drop b. Check wiring at thermostat and boiler terminals

TROUBLESHOOTING – T3R

Problem Display	Possible Cause	Remedy
Thermostat display is blank	Batteries exhausted, installed incorrectly or tab hasn't been removed	Pull thermostat from wall bracket or table stand and check battery installation - replace batteries if necessary
Display shows 	Battery power critically low	Pull thermostat from wall bracket or table stand and check battery installation - replace batteries if necessary
Display shows 	Faulty temperature sensor	Replace thermostat or check wiring to remote temperature sensor if fitted
Thermostat shows heat demand  but boiler doesn't respond	a. Boiler water already at temperature b. Faulty wiring connection	a. Normal behaviour – wait for water temperature to drop b. Check wiring at thermostat and boiler terminals
Thermostat displays shows  and Receiver Box  LED is flashing RED	Wireless communication with Receiver Box is lost	Move thermostat to a location where wireless communication is reliable
Thermostat displays shows  and Receiver Box  LED is flashing OFF	Thermostat and Receiver Box not bound	Move thermostat to a location where wireless communication is reliable
Receiver Box  LED is flashing ORANGE	Receiver Box is in bind mode	Wait for bind mode to time out (3min) or bind a Thermostat

ORDERING SPECIFICATION

Description	Model	EAN code	Literature
T3 Wired Thermostat	T3H110A0066	5025121380553	All packaging contains a user guide and installation guide in English
T3 Wired Thermostat for OpenTherm Boilers	T3H310A0045	5025121380492	
T3 Wireless Thermostat	Y3H710RF0053	5025121380546	
Spare Receiver Box	R3H710RF0005	5025121380362	
Spare Wireless Thermostat	T3H700RF0096	5025121380393	

T3 PROGRAMMABLE THERMOSTAT

OpenTherm® ID's (only for T3M)

Menu item	Standaard	Wat wilt u aanpassen?
OT1: Low Load Control	1= Enabled	0= Disabled 1= Enabled
OT2: Control setpoint		5 - 99°C
OT3: Supply water temperature		5 - 99°C
OT4: Return water temperature		5 - 99°C
OT5: Max. supply water temperature		5 - 99°C
OT6: Hot water temperature		5 - 99°C
OT7: Hot water setpoint		5 - 99°C
OT8: Actual power		0 – 99%
OT9: Water pressure		0.0 – 9.9
OT10: OTC control	0= Disabled	0= Disabled 1= Enabled
OT11: OTC curve	16	4-40
OT12: Room compensation	0= Disabled	0= Disabled 1= Enabled

PRODUCT NOTICE

Product(s) contains LEAD CAS-Nr. 7439-92-1 and Diboron Trioxide CAS-Nr. 1303-86-2 in article (s).
REACH - Regulation: (EC) No 1907/2006 of 18 December 2006; Title IV, Article 33.(1).
SVHC – ECHA Decision ED/61/2018 of 20 June 2018; SVHC List of 27 June 2018.



resideo

Resideo Inc., Skimped Hill Lane,
Bracknell, Berkshire, RG12 1EB.

www.resideo.com

Country of origin : UK

©2018 Resideo Technologies, Inc. All rights reserved. The Honeywell Home trademark is used under license from Honeywell International Inc.

Honeywell Home