

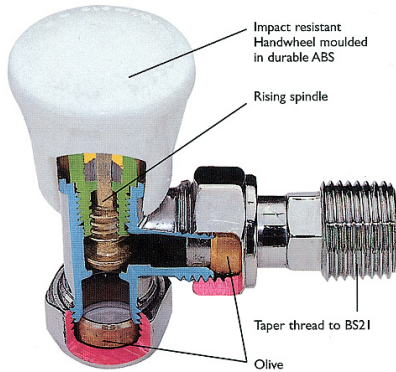

MATCHMATE



- Maximum operating pressure 10 Bar.
- Pressure tested in accordance with BS 2767.
- Maximum water temperature 120°C.
- Available in high quality Nickel or Brass finish.
- Available with drain off facility.

DIMENSIONS

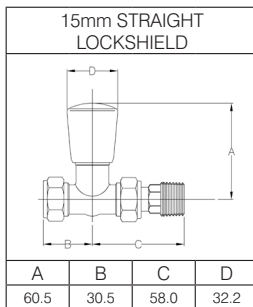
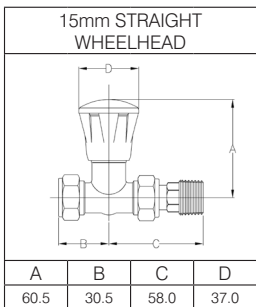
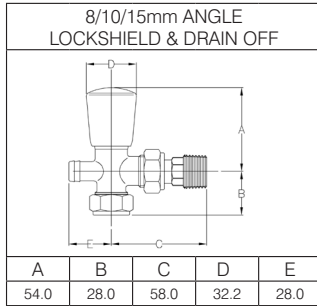
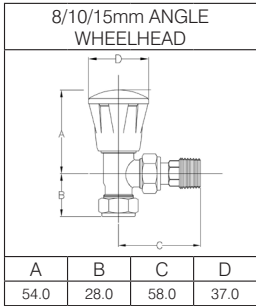

PRESSURE DROP

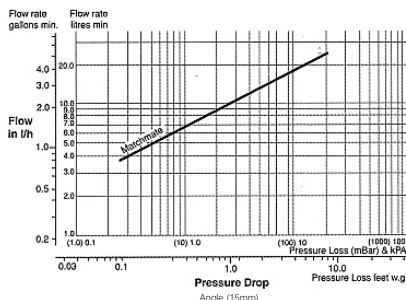

EURO LOCKSHIELD

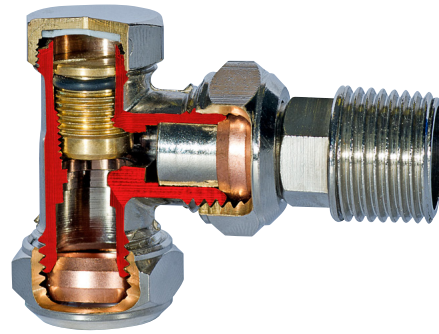

- Maximum operating pressure 10 Bar.
- Pressure tested in accordance with BS 2767.
- Maximum water temperature 120°C.
- Available in high quality Nickel finish.
- Available with drain off facility.

DIMENSIONS

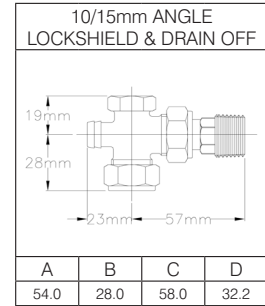
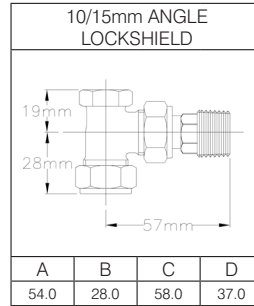

PRESSURE DROP

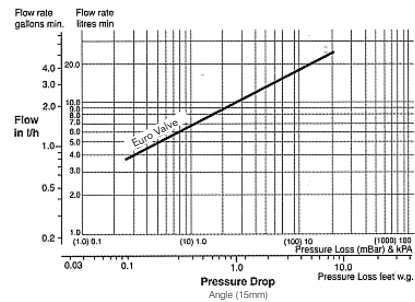

LOCKSHIELD WITH DRAIN OFF FACILITY FOR BOTH MATCHMATE AND EUROVALVE

Operation

- Close radiator valves.
- Place drip tray under drain off.
- Open radiator air vent screw to release the pressure and close, then remove drain off plug.
- Fit hosepipe or use a suitable reseptic.
- Open radiator vent screw (Note: The flow from the drain off can be stopped by closing air vent).
- When drain off is completed close radiator air vent screw and replace drain off plug.

